



**KEY FEATURES:**

- Purified dock water for drinking, cooking, and bathing with no equipment on the dock needed
- Removes up to 99% of TDS
- Removes viruses, bacteria, and cysts
- Spot-free wash-down saves time, with no need to chamois-dry surfaces
- Extends your vessel's paint and wax life
- Compact, space-saving design
- Pumps and motors included
- Extremely low power consumption
- Exceptionally low noise and vibration
- Wall- or deck-mountable
- Optional HMI Remote Display

**PURIFY DOCK WATER  
WITH ONE CONVENIENT UNIT**

The FCI Dockside Treatment System (DTS) is another FCI Watermakers innovation, specifically designed to treat dock water. The FCI DTS+Solo is a stand-alone dockside water purifying unit allowing you to enjoy fresh purified drinking, cooking, and bath water from your dockside source. Its compact, modular design allows it to be tucked away just about anywhere. This advanced system includes a GAC and sediment filter, making it optimized for extended membrane life, which means less maintenance, lower operating costs and more enjoyment out on the water. The FCI DTS+Solo eliminates viruses, bacteria, and cysts. It also removes up to 99% of total dissolved solids (TDS), causing surfaces to dry without leaving water spots. Spend less time wiping down your vessel, and relish the benefits of spot-free wash-downs to extend the life of your vessel's paint and wax finish. The FCI DTS+Solo encompasses all of the qualities and reliability you have come to know with FCI Watermakers.



**FRESH CLEAN WATER**  
*With proven reliability, your FCI DTS provides pure drinking and bath water from your dockside source.*



**ZERO EQUIPMENT ON THE DOCK**  
*Enjoy spot-free wash-downs, and extend the life of your vessel's finish without the need to chamois-dry.*



**HMI REMOTE DISPLAY**  
*The optional display allows remote operation with simple one-touch controls, and intuitive interface.*

**SPECIFICATIONS:**

**WALL MOUNT**

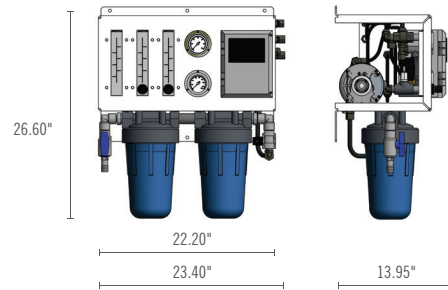

**DECK MOUNT (WITH OPTIONAL BRACKET)**

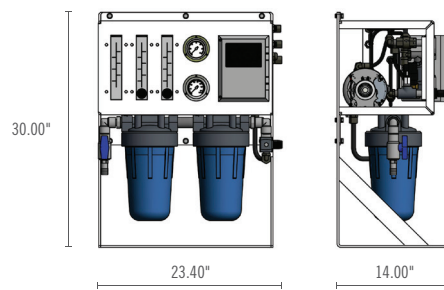

**MODULAR MOUNT**

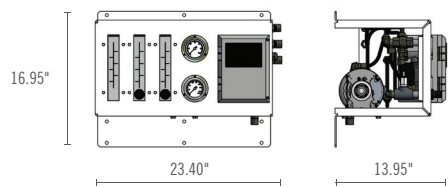

**MEMBRANES (ALL CONFIGURATIONS)**

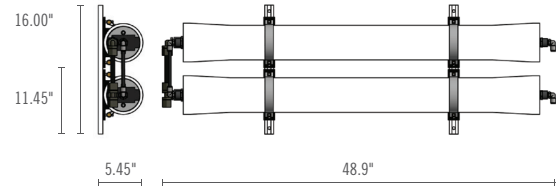

NOTE: Membrane Assembly Bracket height is determined by DTS Model. May include 1 or 2 vessels.

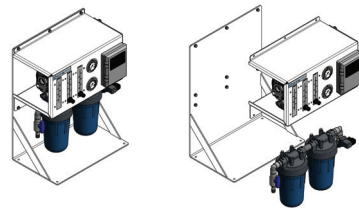
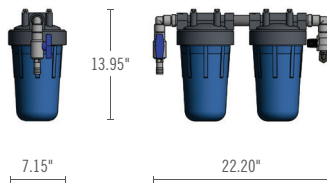

| MODEL         | DESCRIPTION                       | VOLTAGE          |
|---------------|-----------------------------------|------------------|
| DTS+Solo-2000 | 2000 GPD Unit, 1 Membrane Vessel  | 120/240, 50/60hz |
| DTS+Solo-3000 | 3000 GPD Unit, 2 Membrane Vessels | 120/240, 50/60hz |

Municipal feed water conversion up to 1,000 PPM; Chlorine tolerance >0.1



**IN-LINE DTS+ MODELS**  
 For boaters with existing Aquamiser Plus, Max-Q or Max-Q+ Series systems, please ask about our DTS+ and DTS+Auto units.



SPOT-FREE WASHDOWN



KEY FEATURES:

- Produces spot-free rinse, no need to wipe
- No chamoising saves time and money, and puts an end to scratches and swirl marks.
- No hard water buildup, eliminates scaling, stains, pitting and etching
- Helps maintain paint, aluminum, chrome, and glass, leaving zero water spots
- No need for water storage tanks. Simply attach your feed water hose.
- Filter-saving Bypass mode
- Weighs up to 20% less than alternative units
- Intelligent control system with service indicator
- Convenient On/Off touch switch for your safety
- 100% sealed electrical plug with watertight cap
- Produces pure drinking water, eliminating the need for on-board bottled water

SPOT-FREE RINSING WHEREVER, WHENEVER.

The FCI DTS+ (Dockside Treatment System) has been providing spot-free water solutions for decades. The DTS+Mobile now provides boaters with a mobile, spot-free solution from a dockside or municipal source. Simply attach your water supply hose, and choose between unfiltered water for washing or purified spot-free water for rinsing. The DTS+ system removes up to 99% of total dissolved solids (TDS), purifying water as low as 5ppm, and leads to a spot-free shine. The DTS+Mobile puts an end to tedious, time-consuming maintenance. Extend the life of your vessel's paint and wax finishes, and spend less time wiping down, polishing and applying compound. Dark colored hulls, no problem. Eliminate pitting and water spot etching, and make quick work of eisenglass, motor, galleys and metal work. With zero hard water buildup, maintaining your rods and reels, appliances and interior details (bathroom and galley fixtures) are a breeze. The purified water can also be used to fill your freshwater tank. No more cleaning the ice-maker, and do away with on-board bottled water. The cost and time-saving implications are endless. *FCI Watermakers, your reliable water source for over 30 years.*



Spot-free rinse means no swirl marks, etching or scratching.



No more chamois-drying windows, rails, and hard-to-reach areas.

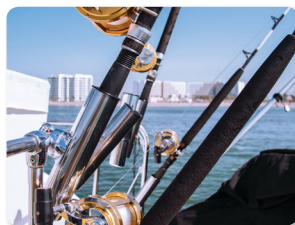

Eliminate hard water build-up on your gear, galley and appliances.



100% sealed electrical plug, and large wheels for easy mobility.

**DTS+MOBILE SYSTEM FEATURES:**

**SAFETY FIRST:** What other piece of equipment do you use that does not have an off switch? We couldn't think of one either. At FCI, we feel any properly engineered electrical machine operating in and around water should have a way to turn it off. Your safety demands it.

**WATER CONSERVATION:** DTS+Mobile is designed to recover as much as 90% of the feed water. The result is cost saving, and more importantly, the conservation of our water resources.

**LOWER OPERATIONAL COSTS:** Selecting Bypass Mode for initial soap up and washdown significantly reduces the cost of operation by preserving the unit's pre-filter and membranes, which allows them to last longer. Less maintenance and cost, equates to a huge operational savings.

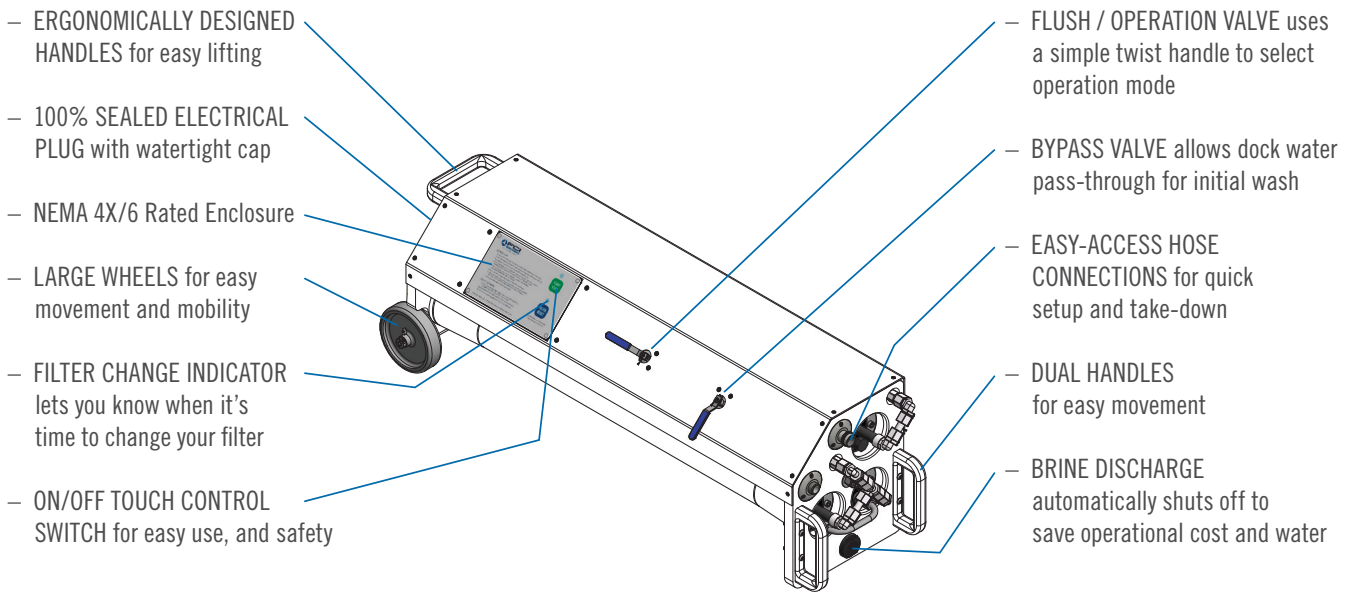

**SPECIFICATIONS:**

**DIMENSIONS**

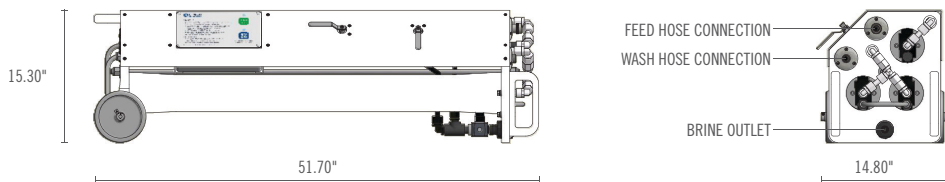

| MODEL      | DESCRIPTION  | VOLTAGE           | WEIGHT  |
|------------|--|-------------------|---------|
| DTS+Mobile | Mobile Spot-free Washdown Unit<br><small>Municipal feed water conversion up to 1,000 PPM; Chlorine tolerance &gt;0.1</small> | 120/240, 50/60hzv | 125 lbs |

**ACCESSORIES**

PN 91-7105      Optional marine-grade cover protects your investment from the elements when not in use.